

PAPER 1 Booklet A

Questions 1 to 10 carry 1 mark each. Questions 11 to 20 carry 2 marks each. For each question, four options are given. One of them is the correct answer. Make your choice (1, 2, 3 or 4). Shade the correct oval (1, 2, 3 or 4) on the Optical Answer Sheet.

(30 Marks)

1 $72\,527 = \underline{\hspace{2cm}} + 500 + 27.$

(1) 7 020

(2) 7 200

(3) 70 200

(4) 72 000

2 Which of the following decimals is the smallest?

(1) 0.35

(2) 0.298

(3) 0.427

(4) 0.51

3 What is the value of the digit 1 in 431 008?

(1) 1 000

(2) 100

(3) 10

(4) 1

4 Which of the following fractions is the greatest?

(1) $\frac{1}{6}$

(2) $\frac{1}{7}$

(3) $\frac{1}{8}$

(4) $\frac{1}{9}$

5 Which of the following could be the height of a classroom door?

(1) 2 cm

(2) 20 cm

(3) 2 m

(4) 200 m

6 The length of each side of a square is 6 cm. What is the area of the square?

(1) 12 cm^2

(2) 24 cm^2

(3) 36 cm^2

(4) 60 cm^2

7 Nathan had \$450. He spent \$90. What percentage of his money did he spend?

(1) 20%

(2) 40%

(3) 50%

(4) 90%

8 One set of 4 hair ties costs \$2. How much must Allya pay for 24 hair ties?

(1) \$24

(2) \$12

(3) \$8

(4) \$6

9 AB and CD are straight lines. Find the value of $\angle y$.

(1) 50°

(2) 60°

(3) 110°

(4) 200°

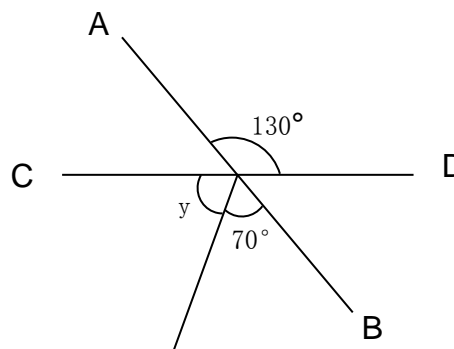

- 10 A machine prints 8 worksheets per minute. At this rate, how many worksheets will the machine print in 1 hour?
- (1) 160
 - (2) 360
 - (3) 480
 - (4) 960
- 11 Which of the following numbers is more than 2.05 but less than 2.51?
- (1) 2.015
 - (2) 2.15
 - (3) 2.515
 - (4) 2.55
- 12 Hafiz had \$5. He spent 60% of the money on a new pen. How much money had he left?
- (1) \$1.50
 - (2) \$1.80
 - (3) \$2.00
 - (4) \$2.20

13 Express 0.25 as a fraction in its simplest form.

(1) $\frac{1}{2}$

(2) $\frac{1}{4}$

(3) $\frac{2}{5}$

(4) $\frac{4}{5}$

14 Mr Ram bought 800 g of sugar. He needed to pour 50 g of sugar in cups. How many cups does he need in all?

(1) 3

(2) 6

(3) 13

(4) 16

15 A rectangle has a length of 17 cm. Its breadth is 12 cm. What is its perimeter?

(1) 29 cm

(2) 58 cm

(3) 102 cm

(4) 204 cm

- 16 The figure shown below is a cube. It has a surface area of 81 cm^2 . What is the volume of the cube?

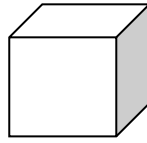

- (1) 27 cm^3
(2) 90 cm^3
(3) 243 cm^3
(4) 729 cm^3
- 17 AB, CD and EF are straight lines. Find $\angle m$.

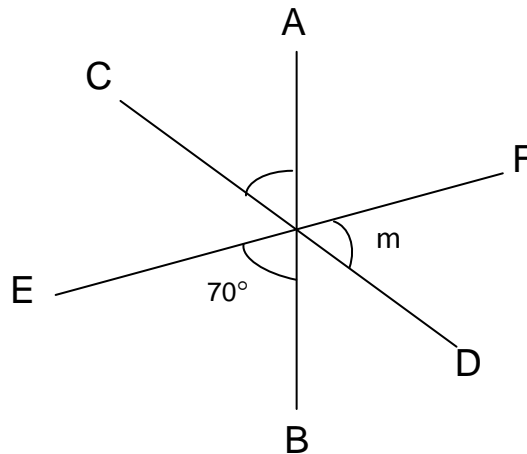

- (1) 50°
(2) 60°
(3) 70°
(4) 110°
- 18 The sum of four numbers is 135. One of the numbers is 34 and another is 37. What is the average of the other two numbers?
- (1) 31
(2) 32
(3) 33
(4) 34

19 Kate bought 88 tea bags. She used 2 tea bags each day from Monday to Thursday and 1 tea bag each on Friday, Saturday and Sunday. How many weeks will it take for Kate to finish all the bags of tea?

(1) 5

(2) 6

(3) 7

(4) 8

20 The opening hours of a café are shown below.

Business Hours	
Tuesday to Friday	9.30 a.m. – 8.00 p.m.
Saturday and Sunday	9 a.m. – 9.30 p.m.
Monday	Closed

How many hours is the café open for business from Monday to Sunday?

(1) 11

(2) 12

(3) 22

(4) 23

-End of Booklet A-

PAPER 1 Booklet B

Questions 21 to 30 carry 2 marks each. Show your working clearly in the space provided for each question and write your answers in the spaces provided. For questions which require units, give your answers in the units stated. Express all answers in simplest forms.

(20 Marks)

- 21 Write the following in figures.
(a) Three thousand and seven

(b) Ninety thousand, four hundred and eighty-six

Ans: (a) _____

Ans: (b) _____

- 22 Mrs Gomez bought some cherries at \$2 per kilogram. The cherries weigh 0.8 kg. How much did she pay for the cherries altogether?

Ans: \$ _____

- 23 A rectangular tank measures 21 cm by 6 cm by 4 cm. What is the volume of the tank?

Ans: _____ cm³

- 24 An adult Resorts World ticket costs \$23 each. Mr Shafik buys 4 adult tickets. How much did Mr Shafik had to pay in total?

Ans: \$ _____

- 25 Hong Lin had a mass of 47 kg last year. Her mass increased by 14 kg this year. What is her mass this year?

Ans: _____ kg

- 26 Myra had a ball of ribbon 4 m long. She used 149 cm of it to tie a present. What was the length of the ribbon Myra had left?

Ans: _____ cm

- 27 In the figure below, ABCD is a rectangle and CDE is an isosceles triangle. $\angle CED = 30^\circ$ and $\angle CDE = 90^\circ$ and $CD = DE$. Find $\angle z$.

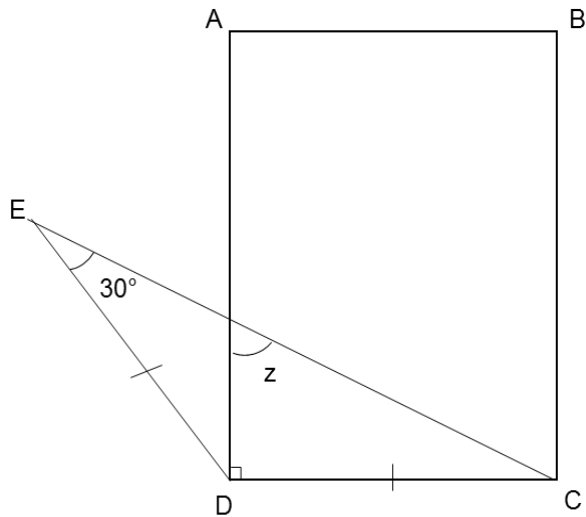

Ans: _____ °

28 Use the graph below to answer Questions 28 and 29.
The graph shows the hobbies of the pupils in a class.

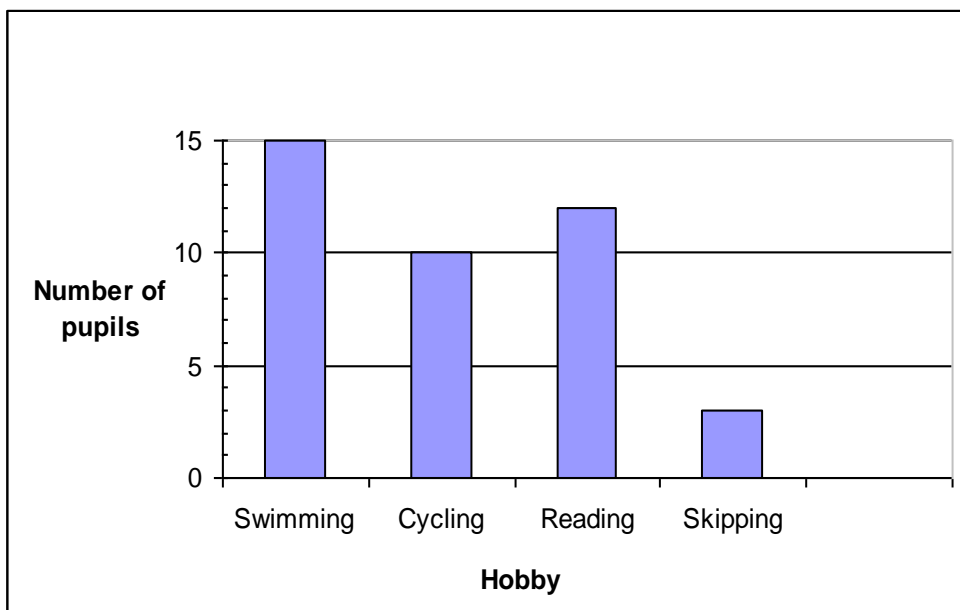

How many more pupils like swimming than reading?

Ans: _____

29 What is the total number of pupils in the class?

Ans: _____

- 30 Ramona deposits \$1500 in a bank for 1 year. The bank offers an annual interest rate of 2%. How much is the interest rate she will have in that year?

Ans: \$ _____

-End of Booklet B-

PAPER 2

Questions 1 to 10 carry 2 marks each. Show your working clearly in the space provided for each question and write your answers in the spaces provided. For questions which require units, give your answers in the units stated. Express all answers in simplest forms.

(20arks)

- 1 (a) List the factors of 12.
- (b) List the common factors of 12 and 15.

Ans: (a) _____

Ans: (b) _____

- 2 Find the value of $3\ 941 \div 510$. Give your answer correct to 2 decimal places.

Ans: _____

- 3 Rahmat has 40 sweets. He gives $\frac{2}{5}$ of them to Yin Xiang. How many sweets has Rahmat left?

Ans: _____ sweets

- 4 Amanda bought some marbles. $\frac{1}{5}$ of the marbles were given to her cousin and $\frac{7}{10}$ of the marbles were given to her friends. What fraction of the marbles were left? (Give your answer in simplest form)

Ans: _____ marbles

- 5 A piece of cloth of length 5.6 m is cut into 7 equal parts. What is the length of each piece of string in centimetres?

Ans: _____ cm

- 6 Alex had \$5. He wanted to buy a file that costs \$2.30, a pen that costs \$1.60 and a notebook. On checking his wallet, he found he needed \$0.30 more to get the notebook. How much does the notebook cost?

Ans: \$ _____

- 7 A class went on a learning journey to Gardens by the Bay from 9.30am to 12.15pm. How long was the learning journey?

Ans: ___h_____min

- 8 A rectangular box measures 13 cm by 11 cm by 6 cm. It is completely filled with 1-cm cubes. How many cubes does the box hold?

Ans: _____ cubes

- 9 In the figure below, not drawn to scale, PQRS is a rectangle and STR is an isosceles triangle. $ST = TR$ and $\angle STR = 40^\circ$. Find $\angle a$.

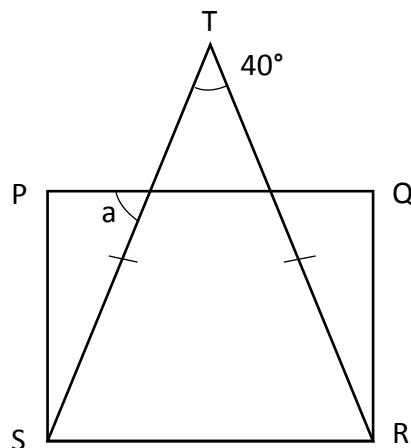

Ans: _____°

10. The figure below is not drawn to scale. Lines JOK and NOP are perpendicular to each other. $\angle LOM = 90^\circ$ and $\angle JOL = 35^\circ$. O is the point where all lines meet. Find $\angle MOP$.

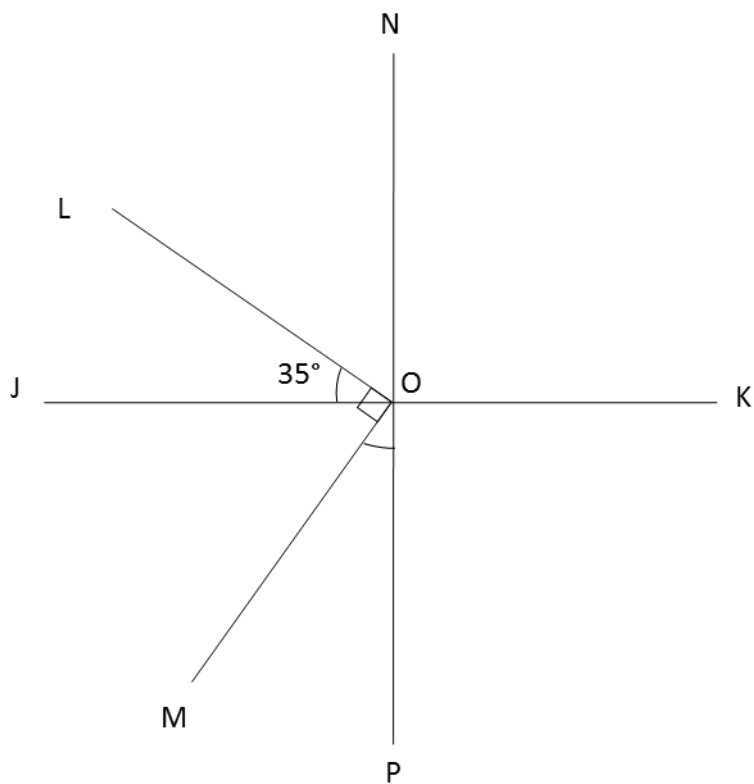

Ans: _____[°]

PAPER 2

For questions 11 to 18, show your working clearly in the space provided for each question and write your answers in the spaces provided. The number of marks available is shown in brackets () at the end of each question or part-question. Express all answers in simplest forms.

(30 marks)

- 11 The line graph shows the number of visitors who went to the Arts Museum over the past five days. What is the average number of visitors on Wednesday and Friday?

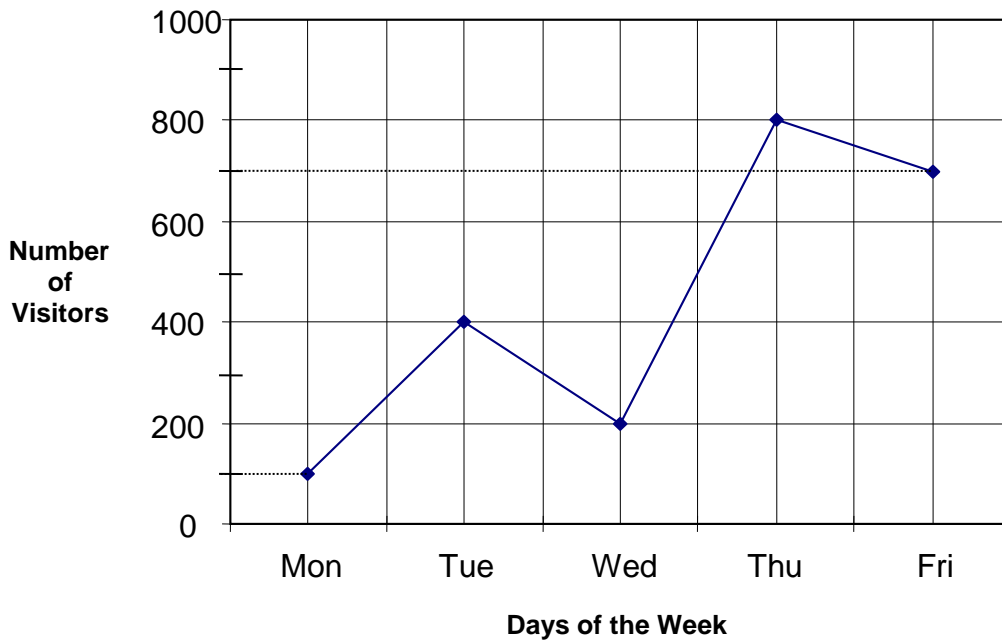

Ans: _____ [2m]

- 12 Mdm Chen had \$4000. She gave \$500 to her daughter and spent $\frac{1}{4}$ of the remaining money on a pair of shoes.
- (a) What fraction of Mdm Chen's money was given to her daughter?
- (b) What was the cost of the pair of shoes?

Ans: (a) _____ [1m]

Ans: (b) _____ [2m]

- 13 Hadri had 600 stamps. He kept 40% of the stamps, gave 180 stamps to his sister and the remaining to his 6 friends.
- (a) What percentage of the stamps did Hadri give to his sister?
- (b) How many stamps did **each** of his friends get?

Ans: (a) _____ [1m]

Ans: (b) _____ [2m]

14 The figure below is a rectangle of length 14 cm and breadth 8 cm.

(a) Find the area of the shaded part of the rectangle.

(b) Find the area of the unshaded part of the rectangle.

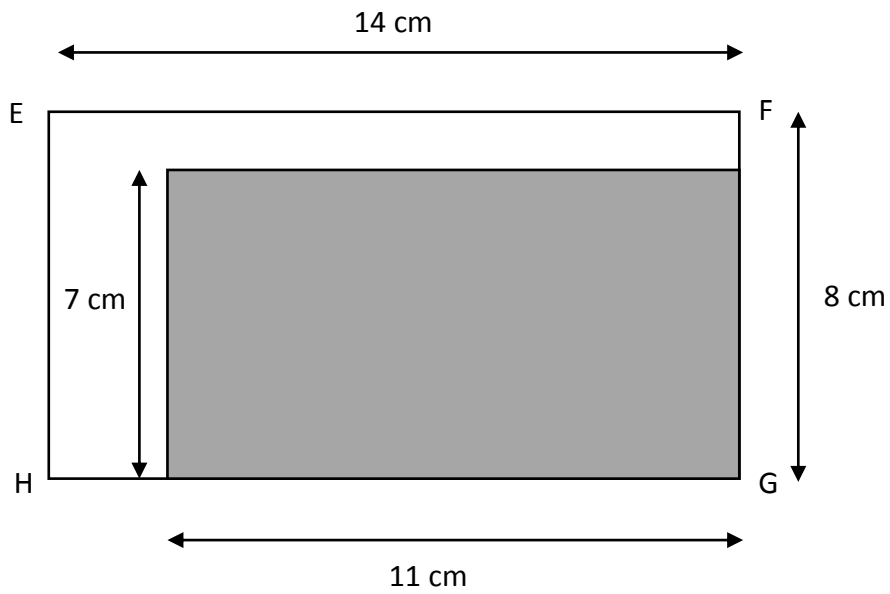

Ans: (a) _____ [1m]

Ans: (b) _____ [2m]

15 The figure below is not drawn to scale. UWX is an equilateral triangle and XYZ is a right-angled triangle. $\angle XZY$ is 58° and UXZ is a straight line.

(a) Find $\angle WXZ$.

(b) Find $\angle UXY$.

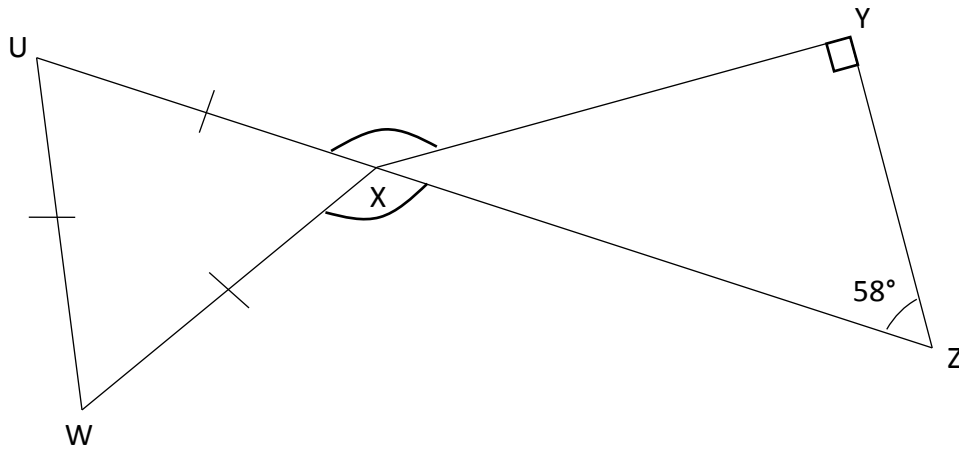

(a) _____ [2m]

Ans: (b) _____ [2m]

- 16 The figures below are Glass Tanks A and B that contain water. Glass Tank A measures 29 cm by 22 cm by 10 cm while Glass Tank B measures 50 cm by 30 cm by 11 cm.

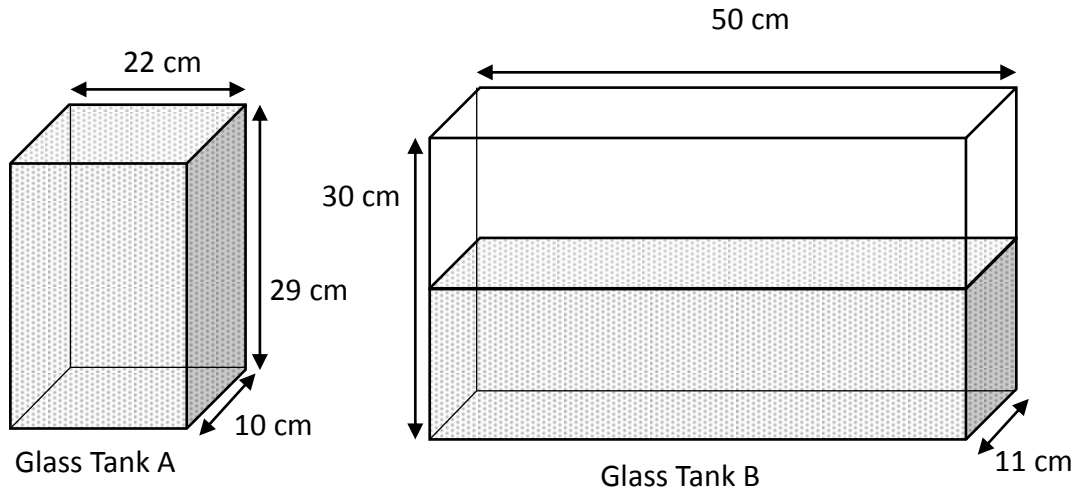

- (a) What is the difference in the volume of the two tanks?
- (b) The height of water in Glass Tank B is half of the actual length of the tank. How much more water is needed to fill Glass Tank B to the brim?

Ans: (a) _____ [2m]

Ans: (b) _____ [2m]

17 Kayla and Mary have the same number of jellybeans each. Sofia has 30 more jellybeans than Mary. When all the jellybeans are shared equally among the three girls, each of them receives 80 jellybeans each.

(a) What is the total number of jellybeans shared by the three girls?

(b) How many jellybeans did Sofia have at first?

Ans: (a) _____ [2m]

Ans: (b) _____ [3m]

18 The pie chart shows how Amos spends his monthly salary of \$3 500.

(a) The amount of money Amos spends on his meals is twice the amount he spends on transport. How much does he spend on his meals?

(b) How much does Amos save in a year?

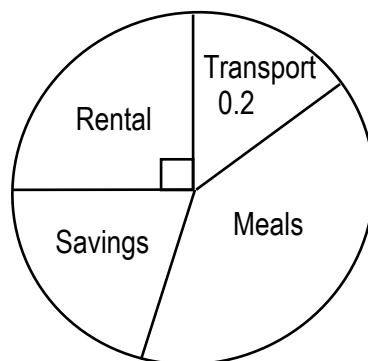

Ans: (a) _____ [3m]

Ans: (b) _____ [3m]